

**60V, 50A N CHANNEL POWER MOSFET**

**GENERAL DESCRIPTION**

The SFM6005ST uses advanced trench technology and design to provide excellent  $R_{DS(on)}$  with low gate charge. It can be used in a wide variety applications.

**Features**

- ◆  $V_{DS}=60V, I_D=50A$
- ◆  $R_{DS(on)}$   
 TYP:  $12.0m\Omega @ V_{GS}=10V$   
 TYP:  $16.0m\Omega @ V_{GS}=4.5V$

**Applications**

- ◆ Power faction correction (PFC)
- ◆ Switched mode power supplies (SMPS)
- ◆ Uninterruptible power supply (UPS)
- ◆ LED lighting power

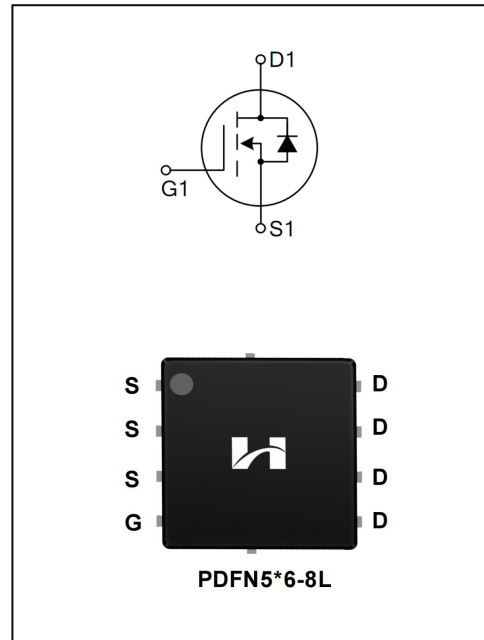

**ORDERING INFORMATION**

Part No.	Package	Marking	Material	Packing
SFM6005ST	PDFN5*6	SFM6005ST	Pb Free	Reel

## ABSOLUTE MAXIMUM RATINGS (T<sub>J</sub>=25°C unless otherwise noted)

Characteristics		Symbol	Ratings	Unit
Drain-Source Voltage		V <sub>DS</sub>	60	V
Gate-Source Voltage		V <sub>GS</sub>	±20	V
Drain Current	T <sub>C</sub> = 25°C	I <sub>D</sub>	50	A
	T <sub>C</sub> = 100°C		32	
Drain Current Pulsed(Note 1)		I <sub>DM</sub>	200	A
Power Dissipation(T <sub>C</sub> =25°C)		P <sub>D</sub>	65	W
-Derate above 25°C			0.42	W/°C
Single Pulsed Avalanche Energy (Note 2)		E <sub>AS</sub>	120	mJ
Operation Junction Temperature Range		T <sub>J</sub>	-55~+150	°C
Storage Temperature Range		T <sub>stg</sub>	-55~+150	°C
Maximum lead temperature for soldering purposes, 1/8" from case for 5 seconds		TL	300	°C

## THERMAL CHARACTERISTICS

Characteristics	Symbol	MAX	Unit
Thermal Resistance, Junction-to-Case	R <sub>θJC</sub>	2.5	°C/W
Thermal Resistance, Junction-to-Ambient	R <sub>θJA</sub>	50	°C/W

## ELECTRICAL CHARACTERISTICS

Characteristics	Symbol	Test conditions	Min.	Typ.	Max.	Unit
<b>Off Characteristics</b>						
Drain -Source Breakdown Voltage	B <sub>VDS</sub>	V <sub>GS</sub> =0V, I <sub>D</sub> =250μA	60	--	--	V
Drain-Source Leakage Current	I <sub>DSS</sub>	V <sub>DS</sub> =60V, V <sub>GS</sub> =0V	--	--	1	uA
Gate-Source Leakage Current	I <sub>GSS</sub>	V <sub>GS</sub> =20V, V <sub>DS</sub> =0V	--	--	100	nA
Gate-Source Leakage Current	I <sub>GSS</sub>	V <sub>GS</sub> =-20V, V <sub>DS</sub> =0V	--	--	-100	
<b>On Characteristics</b>						
Gate Threshold Voltage	V <sub>GS(th)</sub>	V <sub>GS</sub> = V <sub>DS</sub> , I <sub>D</sub> =250μA	1.0	1.5	2.5	V
Static Drain- Source On State Resistance	R <sub>D(on)</sub>	V <sub>GS</sub> =10V, I <sub>D</sub> =20A	--	12.0	20	mΩ
		V <sub>GS</sub> =4.5V, I <sub>D</sub> =10A	--	16.0	29	
<b>Dynamic Characteristics</b>						
Gate Resistance	R <sub>g</sub>	V <sub>GS</sub> =0V; f=1.0MHZ	1	6	10	Ω
Input Capacitance	C <sub>iss</sub>	V <sub>DS</sub> =25V V <sub>GS</sub> =0V f=1.0MHZ	--	1810	--	pF
Output Capacitance	C <sub>oss</sub>		--	115	--	
Reverse Transfer Capacitance	C <sub>rss</sub>		--	95	--	
<b>Switching Characteristics</b>						
Turn-on Delay Time	t <sub>d(on)</sub>	V <sub>DD</sub> =30V, V <sub>GS</sub> =10V R <sub>GS</sub> =25Ω, I <sub>D</sub> =20A (Note 3.4)	--	15.2	--	ns
Turn-on Rise Time	t <sub>r</sub>		--	65.9	--	
Turn-off Delay Time	t <sub>d(off)</sub>		--	165.7	--	
Turn-off Fall Time	t <sub>f</sub>		--	71.4	--	

Total Gate Charge	$Q_g$	$V_{DS}=48V, I_D=20A$ $V_{GS}=10V$ (Note 3.4)	--	45.6	--	nc
Gate-Source Charge	$Q_{gs}$		--	8.7	--	
Gate-Drain Charge	$Q_{gd}$		--	10.5	--	

## SOURCE-DRAIN DIODE RATINGS AND CHARACTERISTICS

Characteristics	Symbol	Test conditions	Min.	Typ.	Max.	Unit
Continuous Source Current	$I_S$	Integral Reverse P-N Junction Diode in the MOSFET	--	--	50	A
Pulsed Source Current	$I_{SM}$		--	--	200	
Diode Forward Voltage	$V_{SD}$	$I_S=20A, V_{GS}=0V$	--	0.8	1.2	V
Reverse Recovery Time	$T_{rr}$	$I_F=20A$ $dI_F/dt=100A/\mu S$	--	67	--	ns
Reverse Recovery Charge	$Q_{rr}$		--	22	--	nC

1. Pulse width limited by maximum junction temperature
2.  $L=1mH, V_{DD}=50V, V_G=10V, R_G=25\Omega$ , starting  $T_J=25^\circ C$
3. Pulse Test: Pulse width  $\leq 300\mu s$ , Duty cycle  $\leq 2\%$
4. Essentially independent of operating temperature

Typical Performance Characteristics

Figure 1. Output Characteristics

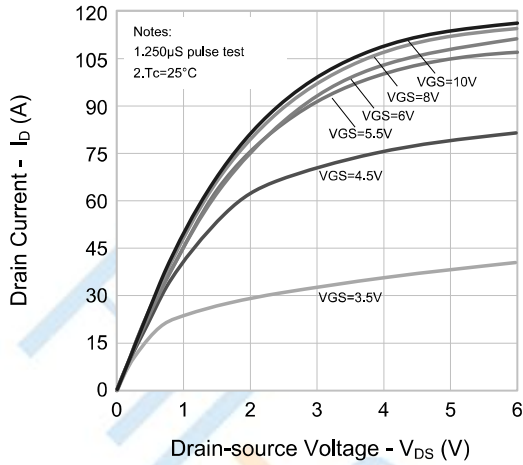

Figure 2. Transfer Characteristics

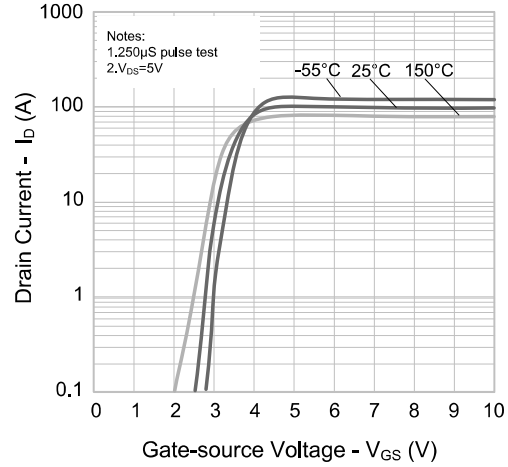

Figure 3. On-resistance vs. Drain Current

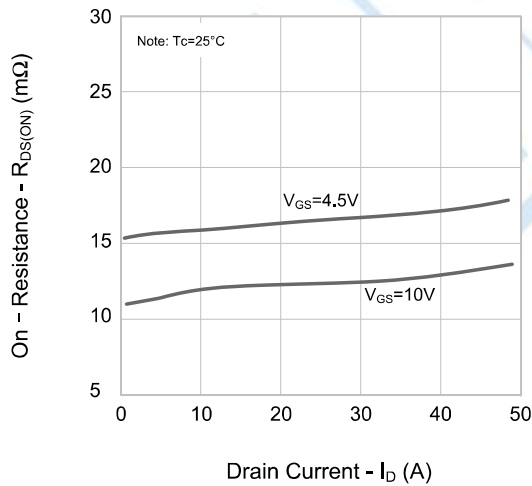

Figure 4. Body Diode Forward Voltage Variation vs. Source Current and Temperature

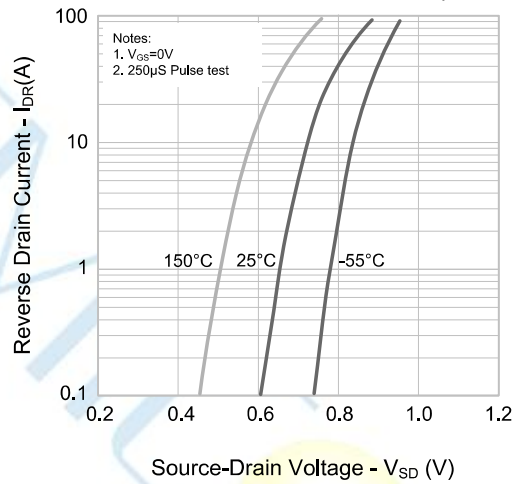

Figure 5. Capacitance Characteristics

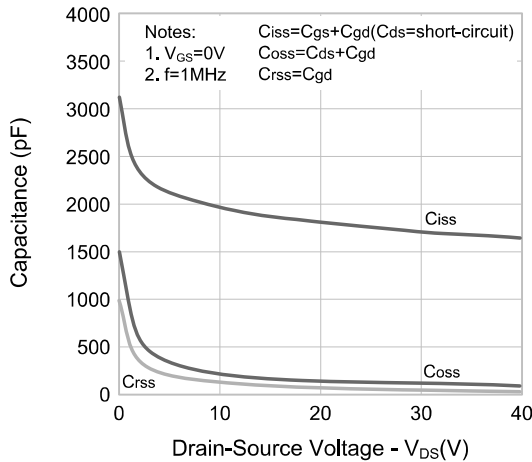
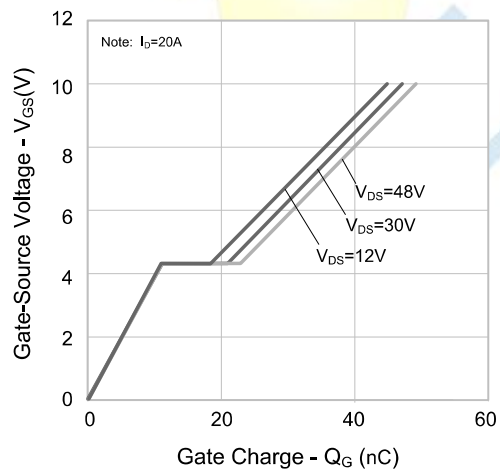

Figure 6. Gate Charge



Typical Performance Characteristics

Figure 7. Breakdown Voltage vs. Temperature Characteristics

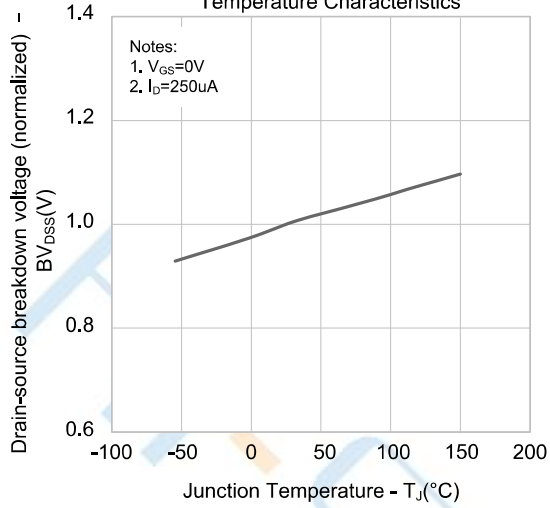

Figure 8. On-resistance vs. Temperature Characteristics

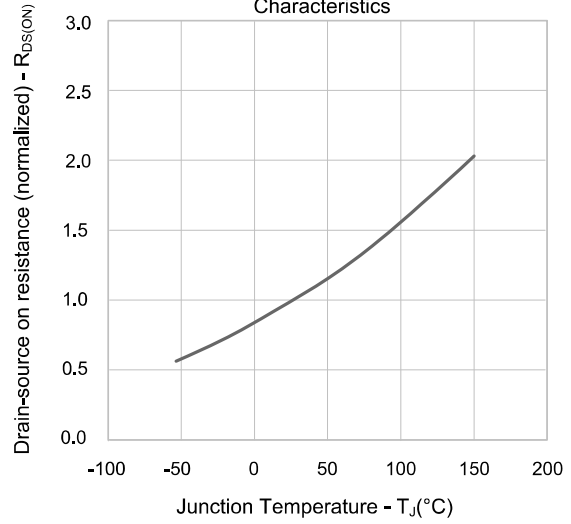
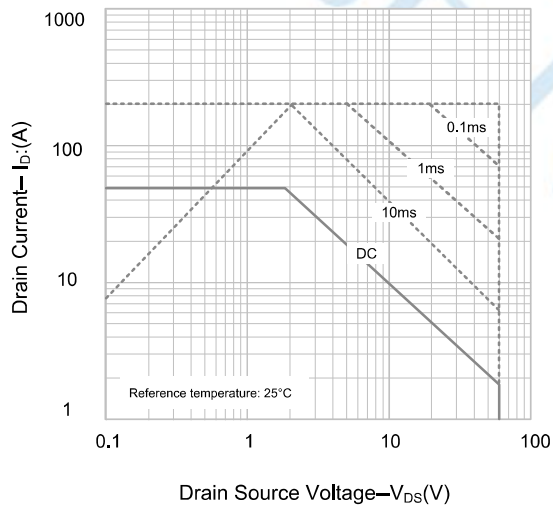
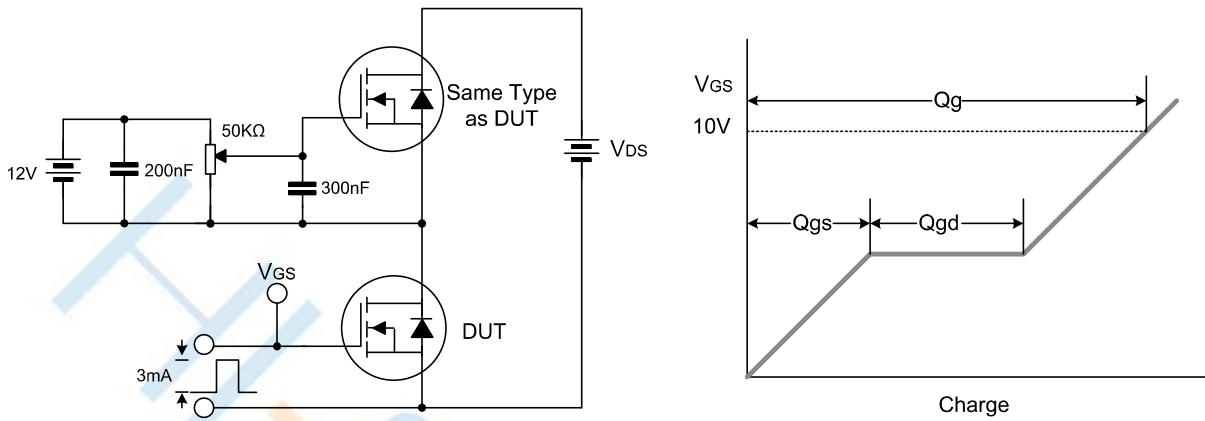

Figure 9. Max. Safe Operating Area



Test Circuit

Gate Charge Test Circuit & Waveform



Resistive Switching Test Circuit & Waveform

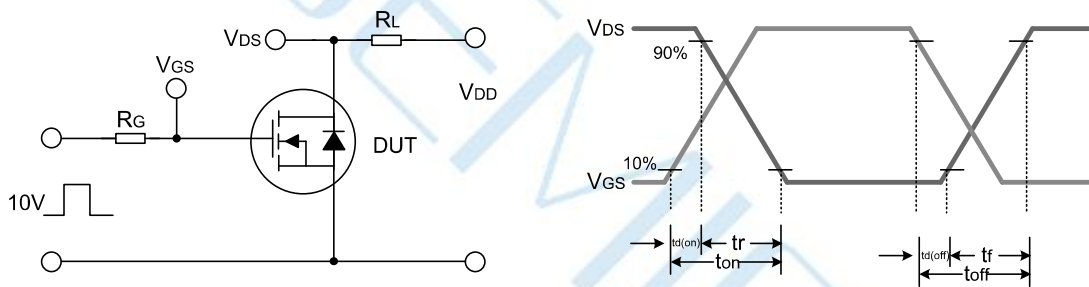

Unclamped Inductive Switching Test Circuit & Waveform

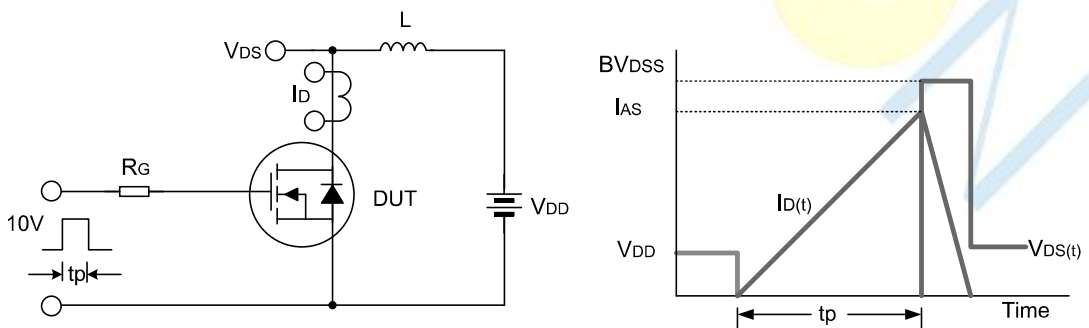

Package Dimensions of PDFN5\*6-8L

Unit:mm

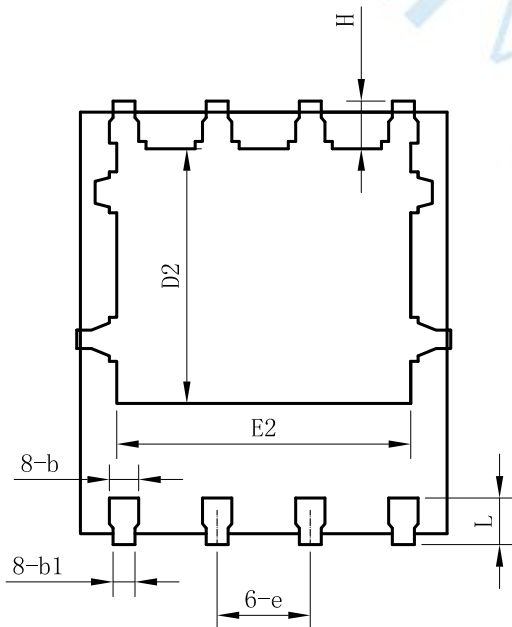
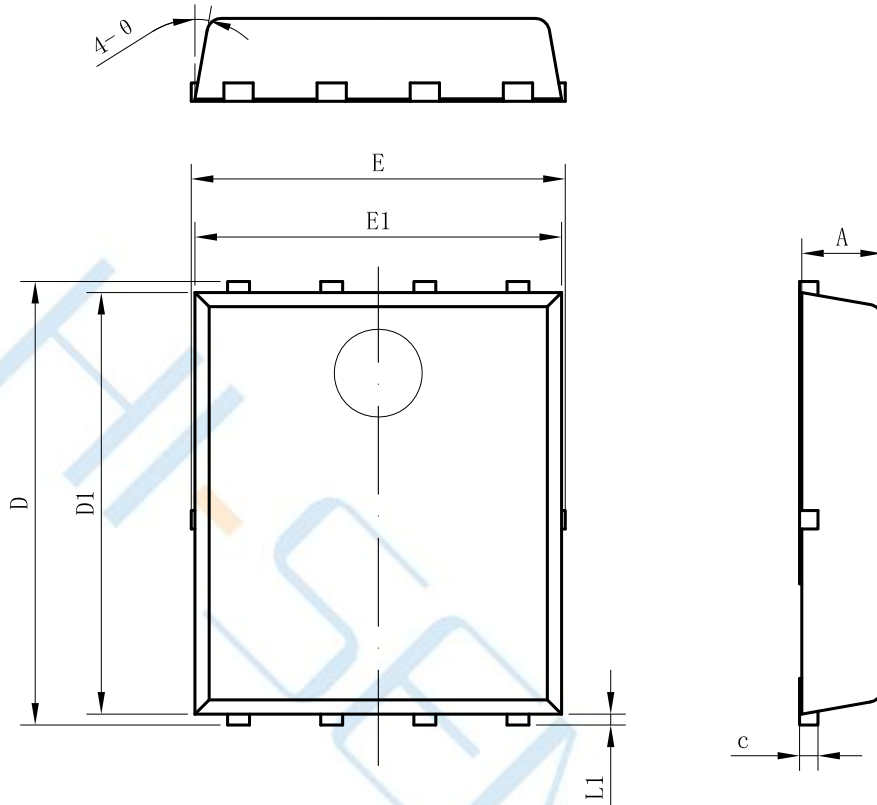

COMMON DIMENSIONS  
(UNITS OF MEASURE=MILLIMETER)

SYMBOL	MIN	NOM	MAX
A	1.0	1.1	1.2
b	0.35	0.4	0.45
b1		(0.3)	
c	0.2	0.25	0.35
D	5.9	6.05	6.2
D1	5.65	5.75	5.85
D2		(3.475)	
E			5.2
E1	4.9	5	5.1
E2		(4.01)	
e		1.27BSC	
H	0.5	0.65	0.75
L	0.51	0.635	0.75
L1		0.15	
θ		10°	

**Disclaimer:**

- ▶ Hi-semicon reserves the right to make changes to the information herein for the improvement of the design and performance without further notice! Customers should obtain the latest relevant information before placing orders and should verify that such information is complete and current.
- ▶ All semiconductor products malfunction or fail with some probability under special conditions. When using Hi-semicon products in system design or complete machine manufacturing, it is the responsibility of the buyer to comply with the safety standards strictly and take essential measures to avoid situations in which a malfunction or failure of such Hi-semicon products could cause loss of body injury or damage to property.
- ▶ Hi-semicon will supply the best possible product for customers!